

JVC

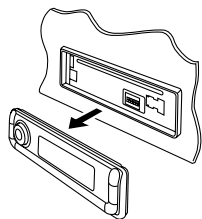

CD RECEIVER

KD-G814

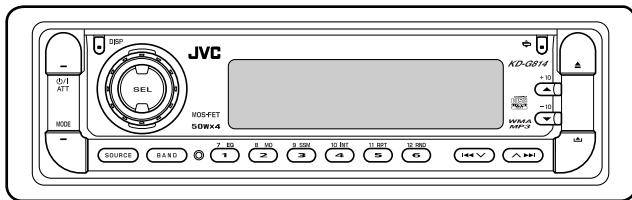
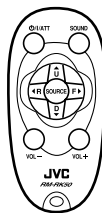

WMA MP3

For canceling the display demonstration, see page 8.

For installation and connections, refer to the separate manual.

INSTRUCTIONS

GET0306-001A
[U]

Thank you for purchasing a JVC product.

Please read all instructions carefully before operation, to ensure your complete understanding and to obtain the best possible performance from the unit.

IMPORTANT FOR LASER PRODUCTS

1. CLASS 1 LASER PRODUCT
2. **CAUTION:** Do not open the top cover. There are no user serviceable parts inside the unit; leave all servicing to qualified service personnel.
3. **CAUTION:** Visible and invisible laser radiation when open and interlock failed or defeated. Avoid direct exposure to beam.
4. REPRODUCTION OF LABEL: CAUTION LABEL, PLACED OUTSIDE THE UNIT.

CAUTION: Visible and invisible laser radiation when open and interlock failed or defeated. AVOID DIRECT EXPOSURE TO BEAM.	ADVARSEL: Synlig og usynlig laserstråling når maskinen er åben eller interlocken fejler. Undgå direkte eksponering til stråling.	WARNING: Synlig och osynlig laserstråling när den öppnas och spärren är urkopplad. Beträkta ej strålen.	VARO: Arvattassa ja suojalukitus ohitettuna tai viallisena olet alittina näkyvälle ja näkymättömälle lasersträilylle. Vältä säteiden kohollistamista suoraan itseesi. (f)
--	---	--	--

Warning:

If you need to operate the receiver while driving, be sure to look ahead carefully or you may be involved in a traffic accident.

Caution on volume setting:

Discs produce very little noise compared with other sources. Lower the volume before playing a disc to avoid damaging the speakers by the sudden increase of the output level.

How to reset your unit

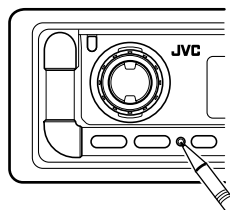

This will reset the microcomputer. Your preset adjustments will also be erased.

How to forcibly eject a disc

If a disc cannot be recognized by the receiver or cannot be ejected, eject the disc as follows.



If this does not work, reset your receiver.

Contents

How to reset your unit	2	Sound adjustments	17
How to forcibly eject a disc	2	Selecting preset sound modes	
How to read this manual	4	(iEQ: intelligent equalizer)	17
How to use the MODE button	4	Adjusting the sound	18
Control panel — KD-G814	5	Storing your own sound adjustments....	19
Parts identification	5	General settings — PSM	20
Remote controller — RM-RK50 ...	6	Basic procedure	20
Main elements and features	6	Other main functions	22
Getting started	7	Assigning titles to the sources	22
Basic operations	7	Changing the control panel angle	23
Canceling the display demonstrations ...	8	Detaching the control panel	23
Setting the clock	8	External component operations... 24	
Radio operations	9	Playing an external component	24
Listening to the radio.....	9	Maintenance	25
Storing stations in memory	10	More about this receiver	26
Listening to a preset station	10	Troubleshooting	28
Disc operations	11	Specifications	31
Playing a disc in the receiver	11		
Playing discs in the CD changer	12		
Other main functions	14		
Changing the display information	15		
Selecting the playback modes.....	16		

***For safety...**

- Do not raise the volume level too much, as this will block outside sounds, making driving dangerous.
- Stop the car before performing any complicated operations.

***Temperature inside the car...**

If you have parked the car for a long time in hot or cold weather, wait until the temperature in the car becomes normal before operating the unit.

How to read this manual

The following methods are used to make the explanations simple and easy-to-understand:

- Some related tips and notes are explained in “More about this receiver” (see pages 26 and 27).
- Button operations are mainly explained with the illustrations as follows:

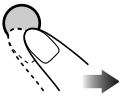
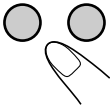
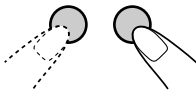
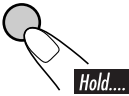
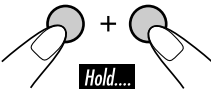
	Press briefly.
	Press repeatedly.
	Press either one.
	
	Press and hold until your desired response begins.
	Press and hold both buttons at the same time.

The following marks are used to indicate...

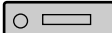
 : Built-in CD player operations.

 : External CD changer operations.

How to use the MODE button

If you press MODE, the receiver goes into functions mode, then the number buttons and ▲/▼ buttons work as different function buttons.

Ex.: When number button 2 works as MO (monaural) button.

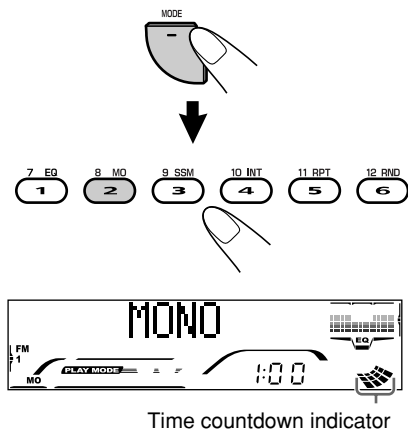

To use these buttons for original functions again after pressing MODE, wait for 5 seconds without pressing any of these buttons until the functions mode is cleared.

- Pressing MODE again also clears the functions mode.

Parts identification

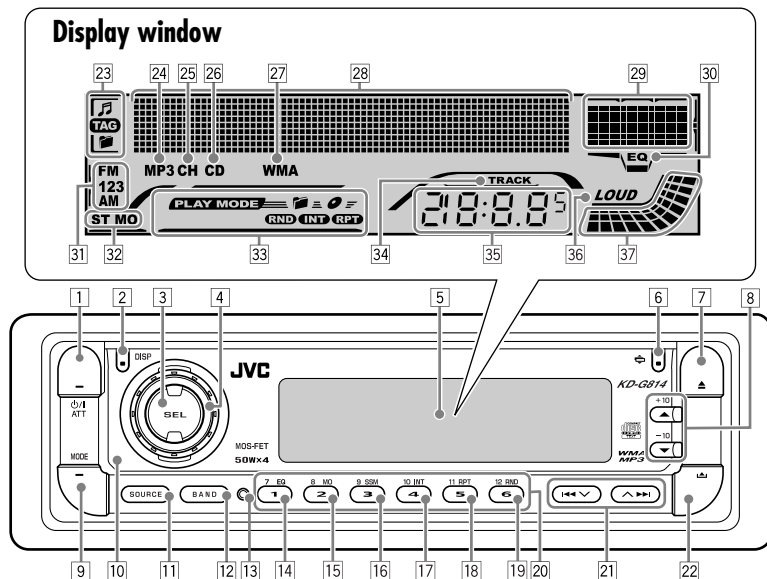

- 1 ϕ /I ATT (standby/on attenuator) button
- 2 DISP (display) button
- 3 SEL (select) button
- 4 Control dial
- 5 Display window
- 6 \curvearrowright (angle) button
- 7 \blacktriangle (eject) button
- 8 \blacktriangle (up) button / +10 button
- 9 MODE button
- 10 Remote sensor
 - *DO NOT* expose the remote sensor to strong light (direct sunlight or artificial lighting).
- 11 SOURCE button
- 12 BAND button
- 13 Reset button
- 14 EQ (equalizer) button
- 15 MO (monaural) button
- 16 SSM (Strong-station Sequential Memory) button
- 17 INT (intro) button
- 18 RPT (repeat) button
- 19 RND (random) button
- 20 Number buttons
- 21 $\llcorner \llcorner \blacktriangleright \blacktriangleright$ buttons
- 22 \blacktriangle (control panel release) button

Display window

- 23 Disc information indicators—TAG (ID3 Tag), \square (track/file), \square (folder)
- 24 MP3 indicator
- 25 CH (CD changer) indicator
 - *Lights up only when CD-CH is selected for the playback source.*
- 26 CD indicator
- 27 WMA indicator
- 28 Main display
- 29 Equalizer pattern indicator
- 30 EQ (equalizer) indicator
- 31 Band indicators—FM1, FM2, FM3, AM
- 32 Tuner reception indicators—ST (stereo), MO (monaural)
- 33 Playback mode / item indicators— \square (folder), \circ (disc), RND (random), INT (intro), RPT (repeat)
- 34 TRACK indicator
- 35 Source / clock display
- 36 LOUD (loudness) indicator
- 37 Audio / volume level indicator

Remote controller — RM-RK50

Installing the lithium coin battery (CR2025)

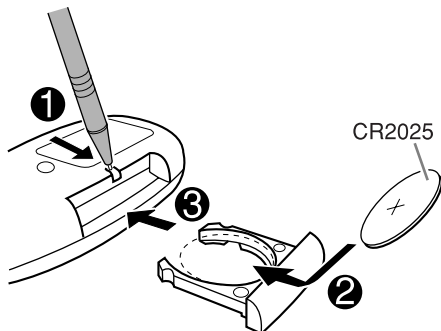

- When operating, aim the remote controller directly at the remote sensor on the receiver. Make sure there is no obstacle in between.

Warning:

- Store the battery in a place where children cannot reach to avoid risk of accident.
- To prevent the battery from over-heating, cracking, or starting a fire:
 - Do not recharge, short, disassemble, or heat the battery or dispose of it in a fire.
 - Do not leave the battery with other metallic materials.
 - Do not poke the battery with tweezers or similar tools.
 - Wrap the battery with tape and insulate when throwing away or saving it.

Caution:

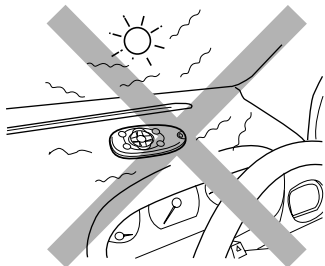

Main elements and features

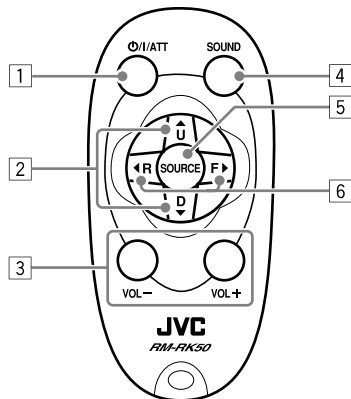

- 1 \odot /I/ATT (standby/on/attenuator) button
 - Turns on and off the power and also attenuates the sound.
- 2 \blacktriangle U (up) / D (down) \blacktriangledown buttons
 - \blacktriangle U: Changes the FM/AM bands.
 - D \blacktriangledown : Changes the preset stations.
 - Changes the folder of the MP3/WMA discs.
 - While playing an MP3 disc on an MP3-compatible CD changer:
 - Changes the disc if pressed briefly.
 - Changes the folder if pressed and held.
- 3 VOL – / VOL + buttons
 - Adjusts the volume level.
- 4 SOUND button
 - Selects the sound mode (iEQ: intelligent equalizer).
- 5 SOURCE button
 - Selects the source.
- 6 \blacktriangleleft R (reverse) / F (forward) \blacktriangleright buttons
 - Searches for stations if pressed briefly.
 - Fast-forwards or reverses the track if pressed and held.
 - Changes the tracks of the disc.

Getting started

Basic operations

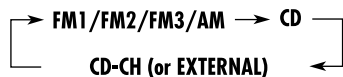
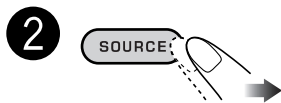
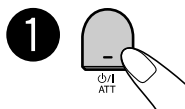
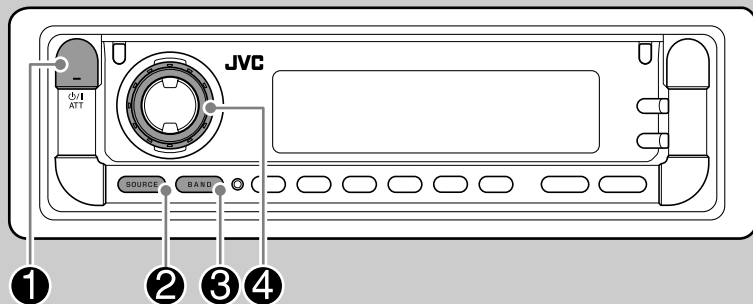

You cannot select some sources if they are not ready.

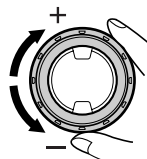
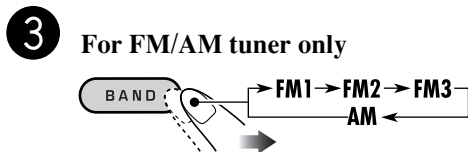

Volume level appears.



Volume level indicator

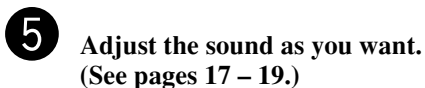

To drop the volume in a moment (ATT)

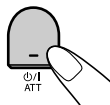

To restore the sound, press it again.

To turn off the power

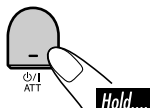

Canceling the display demonstrations

If no operations are done for about 20 seconds, display demonstration starts.

[Initial: DEMO ON]—see page 20.

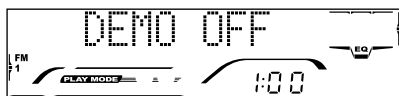
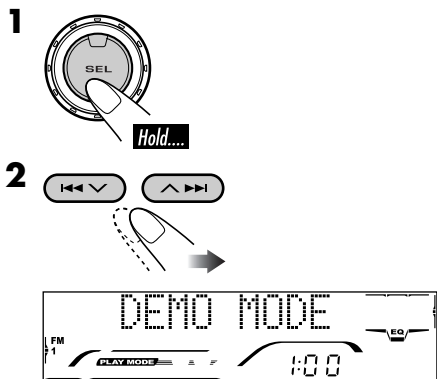

4 Finish the procedure.



To activate the display demonstration

In step **3** above...

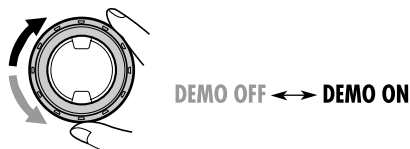

Setting the clock

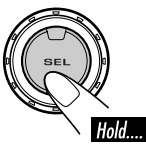
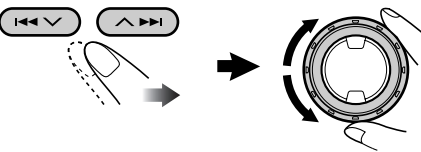
- 1**
- 
- 2** Set the hour and minute.
- 1** Select “CLOCK HOUR,” then adjust the hour.
 - 2** Select “CLOCK MINUTE,” then adjust the minute.
- 
- 3** Finish the procedure.



To check the current clock time when the power is turned off

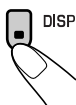

Radio operations

Listening to the radio

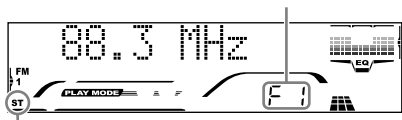
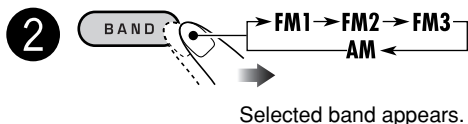
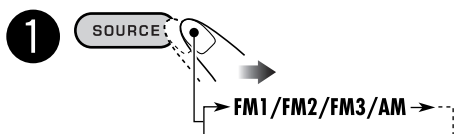
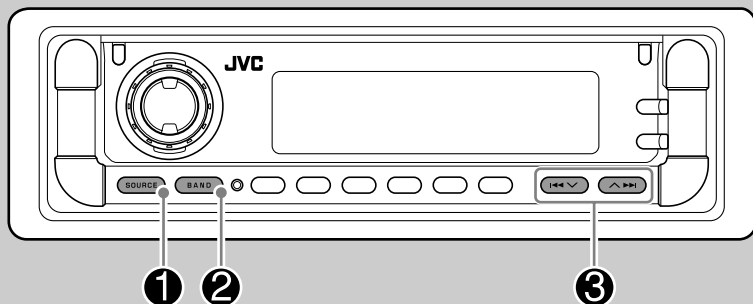

Lights up when receiving an FM stereo broadcast with sufficient signal strength.

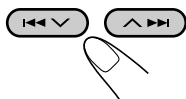

When a station is received, searching stops.

To stop searching, press the same button again.

To tune in to a station manually

In step **3** on the left...

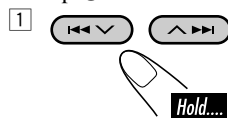

2 Select the desired station frequencies.

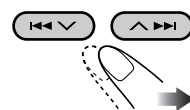

When an FM stereo broadcast is hard to receive

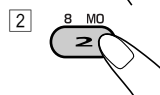
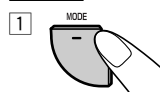

Lights up when monaural mode is activated.

Reception improves, but stereo effect will be lost.

To restore the stereo effect, repeat the same procedure so that the MO indicator goes off.

Storing stations in memory

You can preset six stations for each band.

FM station automatic presetting—SSM (Strong-station Sequential Memory)

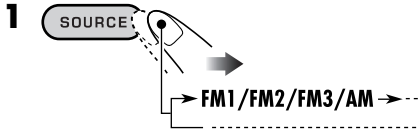

2 Select the FM band (FM1 – FM3) you want to store into.

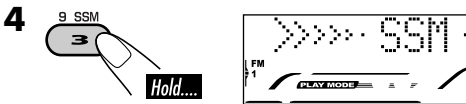
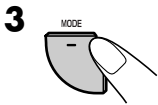
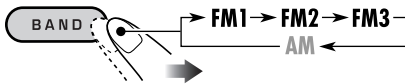

“SSM” appears, then disappears when automatic presetting is over.

Local FM stations with the strongest signals are searched and stored automatically in the FM band.

Manual presetting

Ex.: Storing FM station of 92.5 MHz into the preset number 4 of the FM1 band.

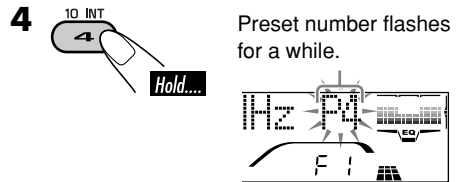
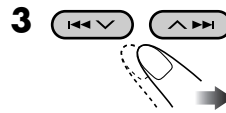
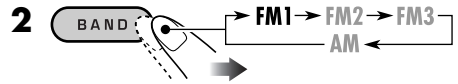
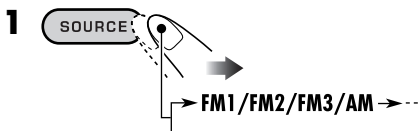

Listening to a preset station

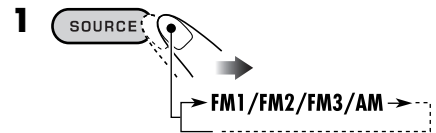

3 Select the preset station (1 – 6) you want.

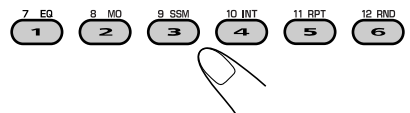

or

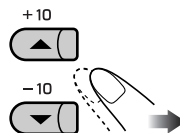

Disc operations

Playing a disc in the receiver

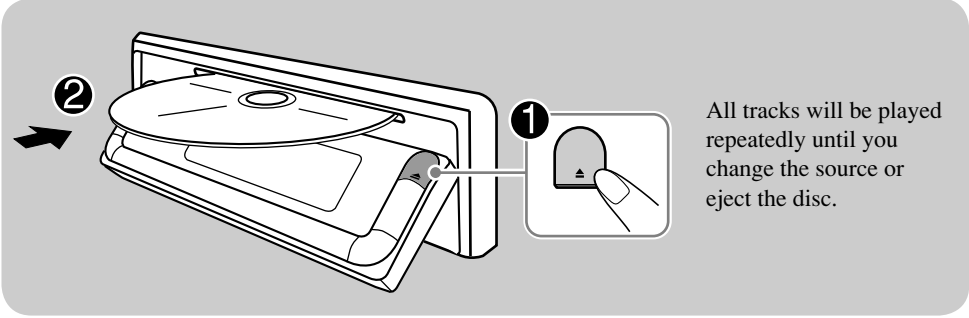

All tracks will be played repeatedly until you change the source or eject the disc.

About MP3 and WMA discs

MP3 and WMA (Windows Media® Audio) “tracks” (words “file” and “track” are used interchangeably) are recorded in “folders.”

- When inserting an audio CD or a CD Text disc:

Total playing time of the inserted disc Total track number of the inserted disc

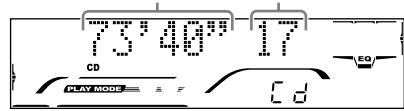

CD Text: Disc title/performer →
Track title appears automatically (see page 15).

Elapsed playing time Current track number

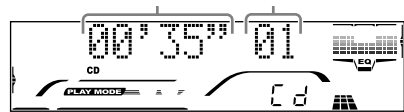

- When inserting an MP3 or a WMA disc:

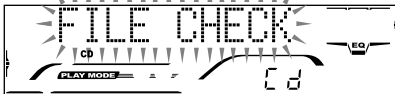

Total folder number Total file number

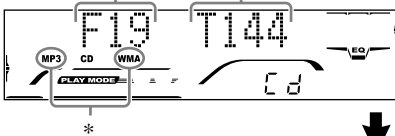

Disc information appears automatically (see page 15).

Elapsed playing time Current track number



Selected folder number

* Either the MP3 or WMA indicator lights up depending on the detected file.

To stop play and eject the disc



The receiver draws the disc, then the control panel goes back to previous position (see page 23).

Playing discs in the CD changer

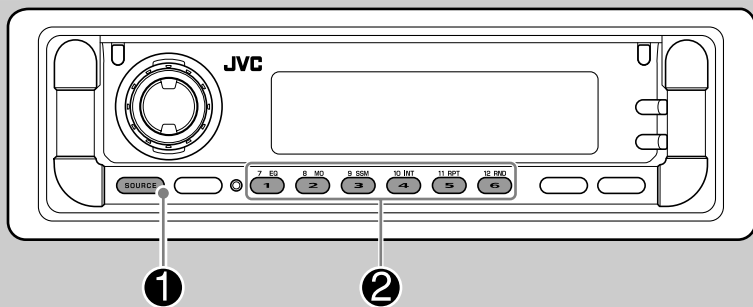

About the CD changer

It is recommended to use the JVC MP3-compatible CD changer with your receiver.

- You can also connect other CH-X series CD changers (except CH-X99 and CH-X100). However, they are not compatible with MP3 discs, so you cannot play back MP3 discs.
- You cannot use the KD-MK series CD changers with this receiver.
- Disc text information recorded in the CD Text can be displayed when a JVC CD Text compatible CD changer is connected.

Before operating your CD changer:

- Refer also to the Instructions supplied with your CD changer.
- You cannot control and play any WMA disc in the CD changer.

All tracks of the inserted discs in the magazine will be played repeatedly until you change the source or eject the magazine from the CD changer.

1

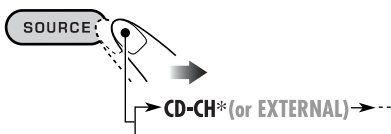

* If you have changed "EXTERNAL IN" setting to "EXTERNAL IN" (see page 21), you cannot select the CD changer.

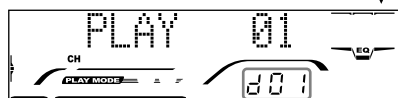
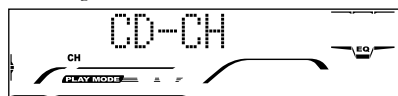

Selected disc number

2

Select a disc.

For disc number from 01 – 06:



For disc number from 07 – 12:



Hold....

- When the current disc is an MP3 disc:

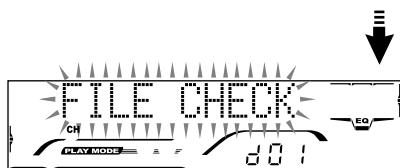

Folder name*



Selected folder number

Disc information appears automatically (see page 15).

Elapsed playing time Current track number



* "ROOT" appears if no folder is included in the disc.

- When the current disc is an audio CD or a CD Text disc:

CD Text: Disc title/performer →
Track title appears automatically (see page 15).

Elapsed playing time Current track number

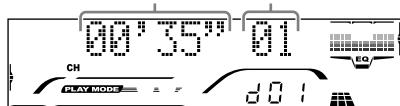

To fast-forward or reverse the track

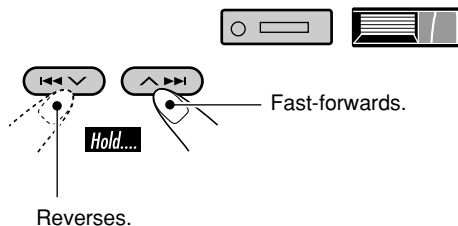

To go to the next or previous tracks

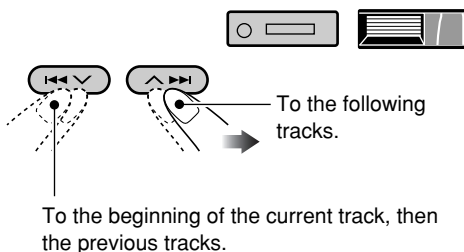

To go to the next or previous folders (only for MP3 and WMA discs)

For MP3 discs:

For WMA discs:

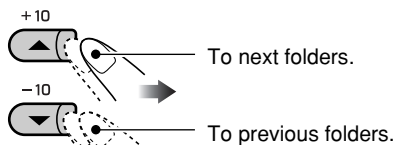

To locate a particular track (for CD) or folder (for MP3 or WMA discs) directly



To select a number from 01 – 06:

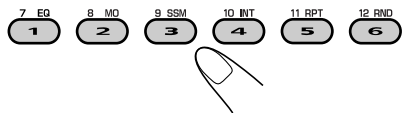

To select a number from 07 – 12:

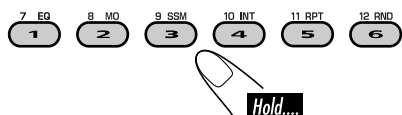

- To use folder search on MP3/WMA discs, it is required that folders are assigned with 2-digit numbers at the beginning of their folder names—01, 02, 03, and so on.

- To select a particular track in a folder (for MP3 or WMA disc) after selecting a folder:

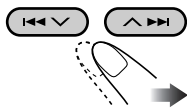

Other main functions

■ Skipping a track quickly during play



- For MP3 or WMA disc, you can skip a track within the same folder.

Ex.: To select track 32 while playing track 6

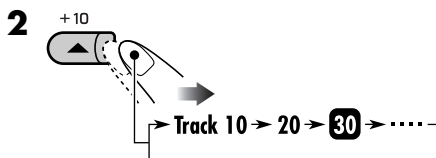
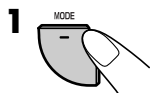

First time you press +10 or -10 button, the track skips to the nearest higher or lower track with a track number of multiple ten (ex. 10th, 20th, 30th).

Then each time you press the button, you can skip 10 tracks.

- After the last track, the first track will be selected and vice versa.

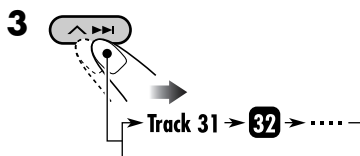

■ Prohibiting disc ejection



You can lock a disc in the loading slot.

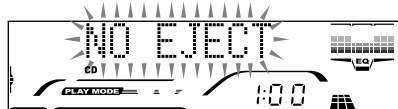

To cancel the prohibition, repeat the same procedure.

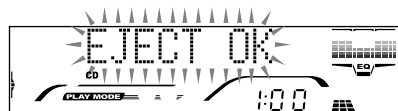

Changing the display information

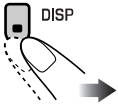

■ While playing an audio CD or a CD Text (/)



*1 If no title is assigned to an audio CD, “NO NAME” appears. To assign a title to an audio CD, see page 22.

■ While playing an MP3 (/) or WMA () disc

- When “TAG DISPLAY” is set to “TAG DISP ON” (see page 21)

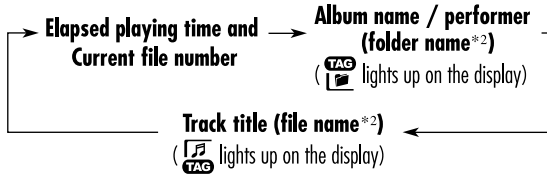

*2 If an MP3/WMA file does not have ID3 tags, folder name and file name appear. In this case, the TAG indicator will not light up.

- When “TAG DISPLAY” is set to “TAG DISP OFF”

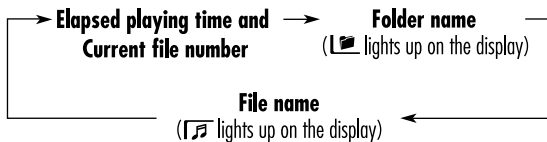

Selecting the playback modes

You can use only one of the following playback modes at a time.

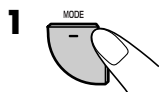

2 Select your desired playback mode.

Repeat play

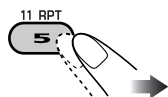

Ex.: When "TRK RPT" is selected while playing an MP3 disc in the receiver

Mode	Plays repeatedly
TRK RPT	: The current track. • RPT lights up.
FLDR RPT*1	: All tracks of the current folder. • and RPT light up.
DISC RPT*2	: All tracks of the current disc. • and RPT light up.
RPT OFF	: Cancels.

Random play

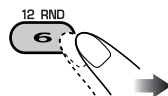

Ex.: When "DISC RND" is selected while playing an MP3 disc in the receiver

Mode	Plays at random
FLDR RND*1	: All tracks of the current folder, then tracks of the next folder and so on. • and RND light up.
DISC RND	: All tracks of the current disc. • and RND light up.
MAG RND*2	: All tracks of the inserted discs. • RND lights up.
RND OFF	: Cancels.

Intro scan

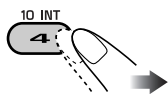

Ex.: When "TRK INT" is selected while playing an MP3 disc in the receiver

Mode	Plays the beginning 15 seconds of...
TRK INT	: All tracks of the current disc. • INT lights up.
FLDR INT*1	: The first track of every folder of the current disc. • and INT light up.
DISC INT*2	: The first tracks of the inserted discs. • and INT light up.
INT OFF	: Cancels.

*1 Only while playing an MP3 (/) or WMA () disc.

*2 Only while playing discs in the CD changer ().

Sound adjustments

Selecting preset sound modes (iEQ: intelligent equalizer)

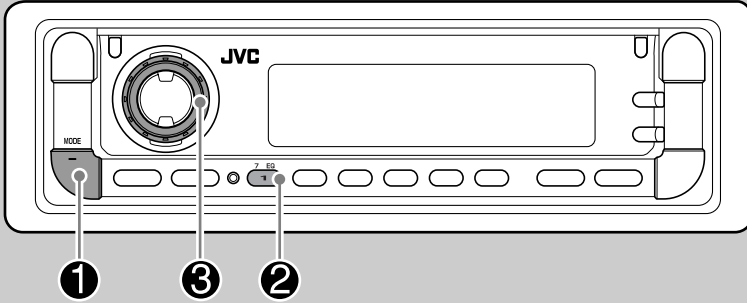

You can select a preset sound mode suitable to the music genre.

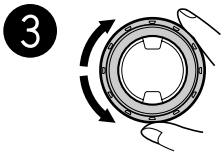
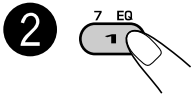
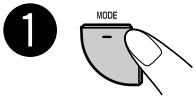

FLAT (no sound mode is applied) ⇄
HARD ROCK ⇄ **R&B** ⇄ **POP** ⇄
JAZZ ⇄ **DANCE MUSIC** ⇄
COUNTRY ⇄ **REGGAE** ⇄
CLASSIC ⇄ **USER 1** ⇄ **USER 2** ⇄
USER 3 ⇄ (back to the beginning)

Indication pattern changes
for each sound mode.



Ex.: When "HARD ROCK" is selected

To select the sound mode directly

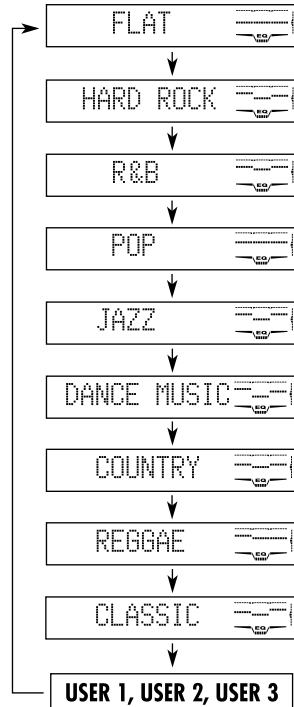
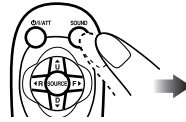

Adjusting the sound

You can adjust the sound characteristics to your preference.

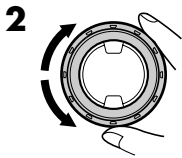
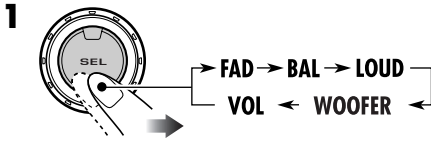

Indication pattern changes as you adjust the fader or balance.

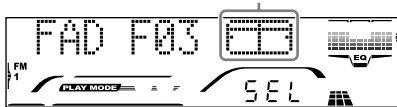

Ex.: When "FAD" is selected

Indication	To do:	Range
FAD* ¹ (fader)	Adjust the front and rear speaker balance.	R06 (Rear only) to F06 (Front only)
BAL (balance)	Adjust the left and right speaker balance.	L06 (Left only) to R06 (Right only)
LOUD (loudness)	Boost low and high frequencies to produce a well-balanced sound at low volume level.	LOUD ON ↓ LOUD OFF
WOOFER* ²	Adjust the subwoofer output level.	00 (min.) to 08 (max.)
VOL* ³ (volume)	Adjust the volume.	00 (min.) to 30 or 50 (max.)* ⁴

*¹ If you are using a two-speaker system, set the fader level to "00."

*² This takes effect only when a subwoofer is connected.

*³ Normally the control dial works as the volume control. So you do not have to select "VOL" to adjust the volume level.

*⁴ Depending on the amplifier gain control setting. (See page 21 for details.)

Storing your own sound adjustments

You can adjust the sound modes and store your own adjustments in memory.

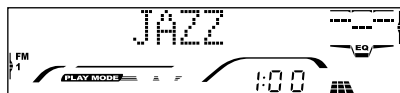
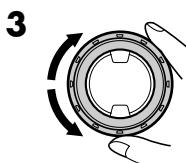
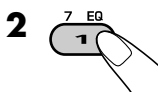
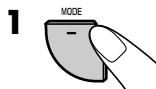

Ex.: When "JAZZ" is selected

4 Select the sound elements to adjust.

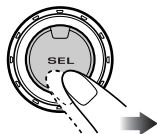

LOW LEVEL* → LOW FREQ →
 LOW WIDTH → MID LEVEL* →
 MID WIDTH → HI (high) LEVEL* →
 HI (high) FREQ → (back to the beginning)

- **LEVEL (LOW, MID, HI):**
Adjust the enhancement level.
- **FREQ (LOW, HI):**
Select the center frequency to adjust.
- **WIDTH (LOW, MID):**
Select the band width level.

* By pressing ◀◀▼ or ▲▶▶, you can directly move as follows:



5 Adjust the selected sound elements.

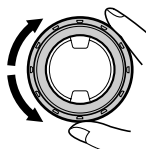

Indication	Preset values		
	LOW	MID	HI
LEVEL	-06 (min.) to +06 (max.)	-06 (min.) to +06 (max.)	-06 (min.) to +06 (max.)
FREQ	60Hz 80Hz 100Hz 120Hz	—	8kHz 10kHz 12kHz 15kHz
WIDTH	1 (min.) to 4 (max.)	1 (min.) to 2 (max.)	—

6 Repeat steps 4 and 5 to set (or adjust) the other sound elements.

7 Select one of the user sound modes (USER 1, USER 2, USER 3).

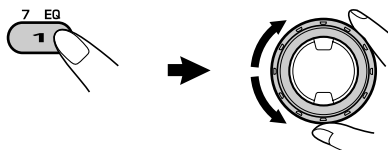

8 Store the adjustments.

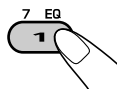

General settings — PSM

Basic procedure

You can change PSM (Preferred Setting Mode) items listed in the table that follows.



2 Select a PSM item.

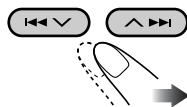

Ex.: When "DIMMER MODE" is selected

3 Adjust the PSM item selected.

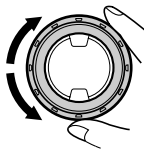

4 Repeat steps **2** and **3** to adjust the other PSM items if necessary.

5 Finish the procedure.



Indications

Selectable settings, [reference page]

DEMO MODE
Display demonstration

DEMO ON : [Initial]; Display demonstration will be activated automatically if no operation is done for about 20 seconds, [8].
DEMO OFF : Cancels.

CLOCK HOUR
Hour adjustment

1 – 12, [8]
[Initial: 1 (1:00)]

CLOCK MINUTE
Minute adjustment

00 – 59, [8]
[Initial: 00 (1:00)]

CLOCK DISP
Clock display

CLK DISP ON : [Initial]; Clock display is shown on the lower part of the display.
CLK DISP OFF : Current source indication (ex. station band, disc number, etc.) is shown on the lower part of the display.
• Press DISP repeatedly to show the other information for about 5 seconds.

LEVELMETER
Audio/volume level meter

LEVEL 1[Initial]/**LEVEL 2**: Display the audio level meter with different illumination pattern.
EQ & LEVEL : Display the equalizer pattern and the audio level meter.
SILENT : Display the equalizer pattern and volume level meter.

Indications	Selectable settings, [reference page]
DIMMER MODE Dimmer	DIMMER AUTO : [Initial]; Dims the display when you turn on the headlights. DIMMER ON : Activates dimmer. DIMMER OFF : Cancels.
TELEPHONE Telephone muting	MUTING 1/MUTING 2 : Select either one which mutes the sounds while using the cellular phone. • If CD or CD changer is selected as the source, playback pauses during telephone muting. MUTING OFF : [Initial]; Cancels.
BEEP SWITCH Key-touch tone	BEEP ON : [Initial]; Activates the key-touch tone. BEEP OFF : Deactivates the key-touch tone.
CONTRAST Display contrast	01 – 10 : Adjust the display contrast to make the display indications clear and legible. [Initial: 08]
SCROLL MODE*1 Scroll	SCROLL ONCE : [Initial]; Scrolls the disc information once. SCROLL AUTO : Repeats scrolling (5-second intervals in between). SCROLL OFF : Cancels. • Pressing DISP for more than one second can scroll the display regardless of the setting.
WOOFER FREQ Subwoofer cutoff frequency	FREQ 55 Hz : Frequencies lower than 55 Hz are sent to the subwoofer. FREQ 85 Hz : [Initial]; Frequencies lower than 85 Hz are sent to the subwoofer. FREQ 115 Hz : Frequencies lower than 115 Hz are sent to the subwoofer.
EXTERNAL IN*2 External input	CHANGER : [Initial]; To use a JVC CD changer, [12]. EXTERNAL IN : To use another external component, [24].
TAG DISPLAY Tag display	TAG DISP ON : [Initial]; Shows the ID3 tag while playing MP3/WMA tracks, [15]. TAG DISP OFF : Cancels.
AMP.GAIN Amplifier gain control	You can change the maximum volume level of this receiver. LOW POWER : VOL 00 – VOL 30 (Select this if the maximum power of the speaker is less than 50 W to prevent them from damaging the speaker.) HIGH POWER : [Initial]; VOL 00 – VOL 50

*1 Some characters or symbols will not be shown (and will be blanked) or substituted on the display.

*2 Displayed only when one of the following sources is selected—FM, AM, or CD.

Other main functions

Assigning titles to the sources

You can assign titles to station frequencies and CDs (both in this receiver and in the CD changer).

Sources	Maximum number of characters
Station frequencies	Up to 9 characters (up to 30 station frequencies including both FM and AM)
CDs/CD-CH*	Up to 32 characters (up to 30 discs)

* You cannot assign a title to a CD Text or an MP3/WMA disc.

1 Select the sources.

- For FM/AM tuner: Select a station.
- For a CD in this receiver: Insert a CD.
- For CDs in the CD changer: Select “CD-CH,” then select a disc number.

2 Enter the title assignment mode.

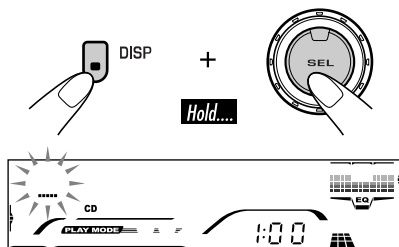

Ex.: When you assign a title to a CD

3 Assign a title.

1 Select a character set.

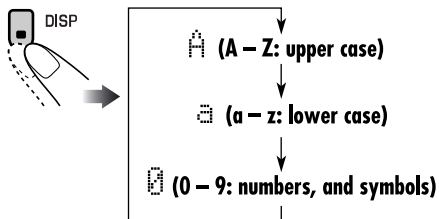

2 Select a character.

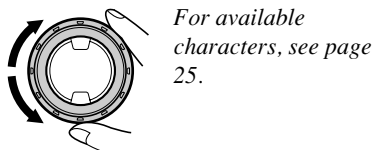

3 Move to the next (or previous) character position.

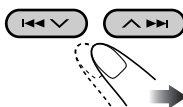

4 Repeat steps 1 to 3 until you finish entering the title.

4 Finish the procedure.



To erase the entire title

In step 2 on the left...

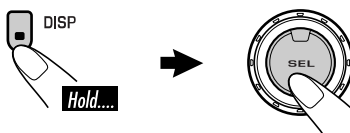

Changing the control panel angle

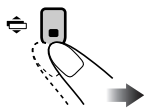

The control panel changes its angle as follows:

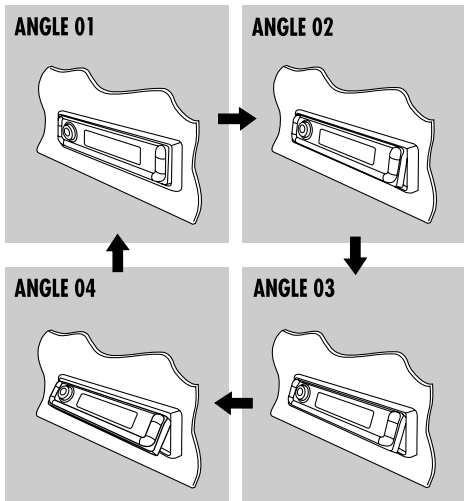

Caution:

Do not insert your finger behind the control panel.

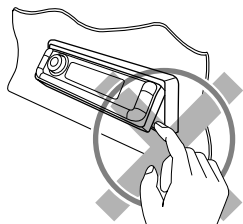

Detaching the control panel

When detaching or attaching the control panel, be careful not to damage the connectors on the back of the control panel and on the panel holder.

■ Detaching the control panel

Before detaching the control panel, be sure to turn off the power.

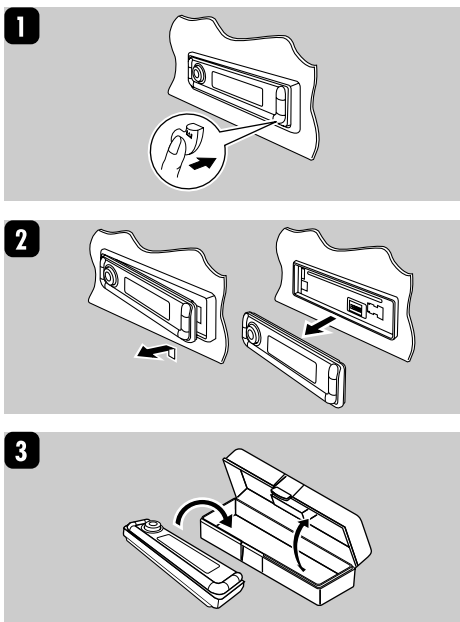

■ Attaching the control panel

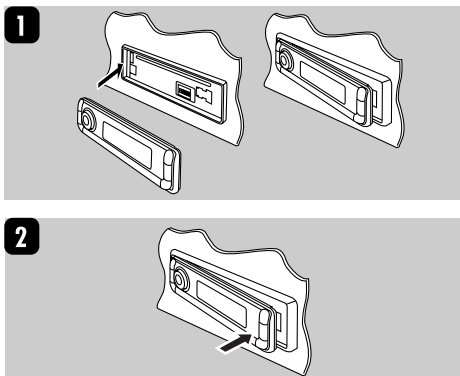

External component operations

Playing an external component

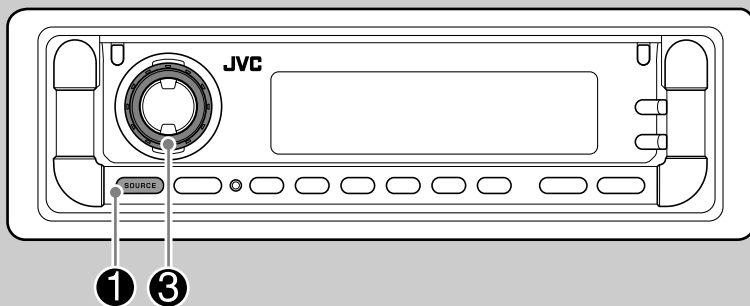

You can connect an external component to the CD changer jack on the rear using the Line Input Adapter KS-U57 (not supplied). Before operating the external component, select the external input correctly (see page 21).

- For connection, see Installation/Connection Manual (separate volume).

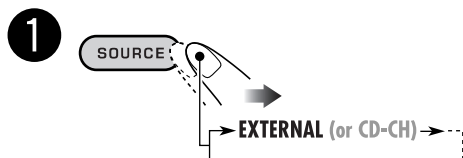

- If “EXTERNAL” does not appear, see page 21 and select the external input (EXTERNAL IN).

2 Turn on the connected component and start playing the source.

3 Adjust the volume.

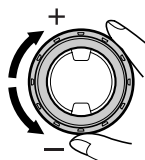

4 Adjust the sound as you want. (See pages 17 – 19.)

Maintenance

How to clean the connectors

Frequent detachment will deteriorate the connectors.

To minimize this possibility, periodically wipe the connectors with a cotton swab or cloth moistened with alcohol, being careful not to damage the connectors.

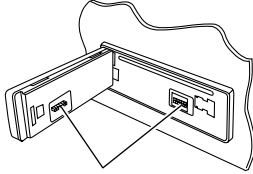

Connector

Moisture condensation

Moisture may condense on the lens inside the CD player in the following cases:

- After starting the heater in the car.
- If it becomes very humid inside the car.

Should this occur, the CD player may malfunction. In this case, eject the disc and leave the receiver turned on for a few hours until the moisture evaporates.

How to handle discs

When removing a disc from its case, press down the center holder of the case and lift the disc out, holding it by the edges.

Center holder



- Always hold the disc by the edges. Do not touch its recording surface.

When storing a disc into its case, gently insert the disc around the center holder (with the printed surface facing up).

- Make sure to store discs into the cases after use.

To keep discs clean

A dirty disc may not play correctly. If a disc does become dirty, wipe it with a soft cloth in a straight line from center to edge.



- Do not use any solvent (for example, conventional record cleaner, spray, thinner, benzene, etc.) to clean discs.

To play new discs

New discs may have some rough spots around the inner and outer edges. If such a disc is used, this receiver may reject the disc.



To remove these rough spots, rub the edges with a pencil or ball-point pen, etc.

Available character

Upper case

A	B	C	D	E	F	G	H	I	J	K	L	M	N
O	P	Q	R	S	T	U	V	W	X	Y	Z	space	

Lower case

a	b	c	d	e	f	g	h	i	j	k	l	m	n
o	p	q	r	s	t	u	v	w	x	y	z	space	

Numbers and symbols

0	1	2	3	4	5	6	7	8	9	!	”	#	\$
%	&	'	()	*	+	,	-	.	/	:	;	<
=	>	?	@	_	`	space							

Do not use the following discs:

Warped disc



Sticker



Sticker residue

Disc



Stick-on label

More about this receiver

Basic operations

Turning on the power

- By pressing SOURCE on the receiver, you can also turn on the power.

Turning off the power

- If you turn off the power while listening to a disc, disc play will start from where playback has been stopped previously, next time you turn on the power.

Selecting the sources

- When no disc is loaded in the receiver, “CD” cannot be selected.
- Without connecting to the CD changer, “CD-CH” cannot be selected.

Tuner operations

Storing stations in memory

- During SSM search...
 - All previously stored stations are erased and stations are stored newly.
 - Received stations are preset in No. 1 (lowest frequency) to No. 6 (highest frequency).
 - When SSM is over, the station stored in No. 1 will be automatically tuned in.
- When storing a station manually, a previously preset station is erased when a new station is stored in the same preset number.

Disc operations

Caution for DualDisc playback

- The Non-DVD side of a “DualDisc” does not comply with the “Compact Disc Digital Audio” standard. Therefore, the use of Non-DVD side of a DualDisc on this product may not be recommended.

General

- This receiver has been designed to reproduce CDs/CD Texts, and CD-Rs (Recordable)/CD-RWs (Rewritable) in audio CD (CD-DA), MP3 and WMA format.
- When a disc has been loaded, selecting “CD” for the playback source starts disc play.

Inserting a disc

- When a disc is inserted upside down, the control panel moves down, and the disc automatically ejects from the loading slot.
- If you keep the control panel open for about 1 minute, (beep sound when the “BEEP SWITCH” setting is turned “BEEP ON”—see page 21) the control panel returns to its previous position.
- Do not insert 8 cm discs (single CD) and unusual shape discs (heart, flower, etc.) into the loading slot.

Playing a disc

- While playing an audio CD: If a title has been assigned to the audio CD (see page 22), it will be shown on the display.
- While fast-forwarding or reversing on an MP3 or WMA disc, you can only hear intermittent sounds.

Playing a CD-R or CD-RW

- Use only “finalized” CD-Rs or CD-RWs.
- This receiver can play back only the files of the same type which is first detected if a disc includes both audio CD (CD-DA) files and MP3/WMA files.
- This receiver can play back multi-session discs; however, unclosed sessions will be skipped while playing.
- Some CD-Rs or CD-RWs may not play back on this receiver because of their disc characteristics, and for the following causes:
 - Discs are dirty or scratched.
 - Moisture condensation occurs on the lens inside the receiver.
 - The pickup lens inside the receiver is dirty.
 - CD-R/CD-RW on which the files are written with “Packet Write” method.
 - There are improper recording conditions (missing data, etc.) or media conditions (stain, scratch, warp, etc.).
- CD-RWs may require a longer readout time since the reflectance of CD-RWs is lower than that of regular CDs.
- Do not use the following CD-Rs or CD-RWs:
 - Discs with stickers, labels, or protective seal stuck to the surface.

- Discs on which labels can be directly printed by an ink jet printer.
- Using these discs under high temperatures or high humidity may cause malfunctions or damage to discs.

Playing an MP3/WMA disc

- This receiver can play back MP3/WMA files with the extension code <.mp3> or <.wma> (regardless of the letter case—upper/lower).
- This receiver can show the names of albums, artists (performer), and ID3 Tag (Version 1.0, 1.1, 2.2, 2.3, or 2.4) for MP3 files and for WMA files.
- This receiver can display only one-byte characters. No other characters can be correctly displayed (see page 25).
- This receiver can play back MP3/WMA files meeting the conditions below:
 - Bit rate: 8 kbps — 320 kbps
 - Sampling frequency:
 - 48 kHz, 44.1 kHz, 32 kHz (for MPEG-1)
 - 24 kHz, 22.05 kHz, 16 kHz (for MPEG-2)
 - 48 kHz, 44.1 kHz, 32 kHz (for WMA)
 - Disc format: ISO 9660 Level 1/ Level 2, Romeo, Joliet, Windows long file name
- The maximum number of characters for file/folder names vary among the disc format used (includes 4 extension characters—<.mp3> or <.wma>).
 - ISO 9660 Level 1: up to 12 characters
 - ISO 9660 Level 2: up to 31 characters
 - Romeo*: up to 128 (72) characters
 - Joliet*: up to 64 (36) characters
 - Windows long file name*: up to 128 (72) characters

* *The parenthetic figure is the maximum number of characters for file/folder names in case the total number of files and folders is 313 or more.*
- This receiver can recognize the total of 512 files, of 200 folders, and of 8 hierarchies.
- This receiver can play back the files recorded in VBR (variable bit rate).
The files recorded in VBR have a discrepancy in elapsed time display, and do not show the actual elapsed time. Especially, after performing the search function, this difference becomes noticeable.

- This receiver cannot play back the following files:
 - MP3 files encoded with MP3i and MP3 PRO format.
 - MP3 files encoded in an unappropriated format.
 - WMA files encoded with Layer 1/2.
 - WMA files encoded with lossless, professional, and voice format.
 - WMA files which are not based upon Windows Media® Audio.
 - WMA files copy-protected with DRM.
 - Files which have the data such as WAVE, AT-RAC3, etc.
- The search function works but search speed is not constant.

Changing the source

- If you change the source, playback also stops (without ejecting the disc).
Next time you select “CD” or “CD-CH” for the playback source, disc play starts from where it has been stopped previously.

Ejecting a disc

- If the ejected disc is not removed within 15 seconds, the disc is automatically inserted again into the loading slot to prevent it from dust. (Disc will not play this time.)

General settings—PSM

- If you have change the “TAG DISPLAY” setting from “TAG DISP OFF” to “TAG DISP ON” while playing MP3/WMA file, the tag display will be activated when the next file starts playing.
- If you change the “AMP.GAIN” setting from “HIGH POWER” to “LOW POWER” while the volume level is set higher than “VOL 30,” the receiver automatically changes the volume level to “VOL 30.”

Other main functions

- If you try to assign a title to a 31st disc or to the 31st station frequency, “NAME FULL” appears. Delete unwanted titles before assignment.
- Titles assigned to discs in the CD changer can also be shown if you playback the disc from the receiver.
- The control panel moves to its previous angle each time you turn on the power.

Troubleshooting

What appears to be trouble is not always serious. Check the following points before calling a service center.

	Symptoms	Causes	Remedies
General	<ul style="list-style-type: none"> • Sound cannot be heard from the speakers. 	<p>The volume level is set to the minimum level.</p> <p>Connections are incorrect.</p>	<p>Adjust it to the optimum level.</p> <p>Check the cords and connections.</p>
	<ul style="list-style-type: none"> • The receiver does not work at all. 	<p>The built-in microcomputer may have functioned incorrectly due to noise, etc.</p>	<p>Reset the receiver (see page 2).</p>
	<ul style="list-style-type: none"> • When “PUSH RESET” appears on the display. 	<p>There is something blocking the control panel movement.</p>	<p>Reset the receiver (see page 2).</p>
FM/AM	<ul style="list-style-type: none"> • SSM automatic presetting does not work. 	<p>Signals are too weak.</p>	<p>Store stations manually.</p>
	<ul style="list-style-type: none"> • Static noise while listening to the radio. 	<p>The antenna is not connected firmly.</p>	<p>Connect the antenna firmly.</p>
Disc playback	<ul style="list-style-type: none"> • Disc cannot be played back. 	<p>Disc is inserted upside down.</p>	<p>Insert the disc correctly.</p>
	<ul style="list-style-type: none"> • CD-R/CD-RW cannot be played back. • Tracks on the CD-R/CD-RW cannot be skipped. 	<p>CD-R/CD-RW is not finalized.</p>	<ul style="list-style-type: none"> • Insert a finalized CD-R/CD-RW. • Finalize the CD-R/CD-RW with the component which you used for recording.
	<ul style="list-style-type: none"> • Disc can be neither played back nor ejected. 	<p>Disc is locked.</p>	<p>Unlock the disc (see page 14).</p>
		<p>The CD player may have functioned incorrectly.</p>	<p>Eject the disc forcibly (see page 2).</p>
	<ul style="list-style-type: none"> • Disc sound is sometimes interrupted. 	<p>You are driving on rough roads.</p>	<p>Stop playback while driving on rough roads.</p>
		<p>Disc is scratched.</p>	<p>Change the disc.</p>
		<p>Connections are incorrect.</p>	<p>Check the cords and connections.</p>
<ul style="list-style-type: none"> • “NO DISC” appears on the display. 	<p>Disc is inserted incorrectly.</p>	<p>Insert the disc correctly.</p>	

	Symptoms	Causes	Remedies
MP3/WMA playback	<ul style="list-style-type: none"> Disc cannot be played back. 	No MP3/WMA tracks are recorded on the disc.	Change the disc.
		MP3/WMA tracks do not have the extension code <.mp3> or <.wma> in their file names.	Add the extension code <.mp3> or <.wma> to their file names.
		MP3/WMA tracks are not recorded in the format compliant with ISO 9660 Level 1, Level 2, Romeo, or Joliet.	Change the disc. (Record MP3/WMA tracks using a compliant application.)
	<ul style="list-style-type: none"> Noise is generated. 	The track played back is not an MP3/WMA file (although it has the extension code <.mp3> or <.wma>).	Skip to another track or change the disc. (Do not add the extension code <.mp3> or <.wma> to non-MP3 or WMA tracks.)
	<ul style="list-style-type: none"> A longer readout time is required (“FILE CHECK” keeps flashing on the display). 	Readout time varies due to the complexity of the folder/file configuration.	Do not use too many hierarchies and folders.
	<ul style="list-style-type: none"> Tracks cannot be played back as you have intended them to play. 	Playback order is determined when the files are recorded.	_____
	<ul style="list-style-type: none"> Elapsed playing time is not correct. 	This sometimes occurs during play. This is caused by how the tracks are recorded on the disc.	_____
	<ul style="list-style-type: none"> “NO FILES” appears on the display. 	The current disc does not contain any MP3/WMA tracks.	Insert a disc that contains MP3/WMA tracks.
<ul style="list-style-type: none"> Correct characters are not displayed (ex. album name). 	This receiver can only display a limited number of special characters (see page 25).	_____	

	Symptoms	Causes	Remedies
CD changer	<ul style="list-style-type: none"> • “NO DISC” appears on the display. 	No disc is in the magazine.	Insert disc into the magazine.
		Disc is inserted upside down.	Insert disc correctly.
	<ul style="list-style-type: none"> • “NO MAG” appears on the display. 	No magazine is loaded in the CD changer.	Insert the magazine.
	<ul style="list-style-type: none"> • “RESET 8” appears on the display. 	This receiver is not connected to the CD changer correctly.	Connect this receiver and the CD changer correctly and press the reset button of the CD changer.
	<ul style="list-style-type: none"> • “RESET 1” – “RESET 7” appears on the display. 	_____	Press the reset button of the CD changer.
<ul style="list-style-type: none"> • The CD changer does not work at all. 	The built-in microcomputer may function incorrectly due to noise, etc.	Reset the receiver (see page 2).	

- Microsoft and Windows Media are either registered trademarks or trademarks of Microsoft Corporation in the United States and/or other countries.

Specifications

AUDIO AMPLIFIER SECTION

Maximum Power Output:

Front: 50 W per channel

Rear: 50 W per channel

Continuous Power Output (RMS):

Front: 19 W per channel into 4 Ω , 40 Hz to 20 000 Hz at no more than 0.8% total harmonic distortion.

Rear: 19 W per channel into 4 Ω , 40 Hz to 20 000 Hz at no more than 0.8% total harmonic distortion.

Load Impedance: 4 Ω (4 Ω to 8 Ω allowance)

Equalizer Control Range:

Low: ± 12 dB (60 Hz, 80 Hz, 100 Hz, 120 Hz)

Mid: ± 12 dB

High: ± 12 dB (8 kHz, 10 kHz, 12 kHz, 15 kHz)

Frequency Response: 40 Hz to 20 000 Hz

Signal-to-Noise Ratio: 70 dB

Line-Out Level/Impedance:

5.0 V/20 k Ω load (full scale)

Output Impedance: 1 k Ω

Subwoofer-Out Level/Impedance:

2.0 V/20 k Ω load (full scale)

Other Terminals:

CD changer, SUBWOOFER

TUNER SECTION

Frequency Range:

FM: 87.5 MHz to 108.0 MHz

AM: 531 kHz to 1 602 kHz

[FM Tuner]

Usable Sensitivity: 11.3 dBf (1.0 μ V/75 Ω)

50 dB Quieting Sensitivity:

16.3 dBf (1.8 μ V/75 Ω)

Alternate Channel Selectivity (400 kHz): 65 dB

Frequency Response: 40 Hz to 15 000 Hz

Stereo Separation: 35 dB

Capture Ratio: 1.5 dB

[AM Tuner]

Sensitivity: 20 μ V

Selectivity: 35 dB

CD PLAYER SECTION

Type: Compact disc player

Signal Detection System: Non-contact optical pickup (semiconductor laser)

Number of Channels: 2 channels (stereo)

Frequency Response: 5 Hz to 20 000 Hz

Dynamic Range: 96 dB

Signal-to-Noise Ratio: 98 dB

Wow and Flutter: Less than measurable limit

MP3 Decoding Format:

MPEG1/2 Audio Layer 3

Max. Bit Rate: 320 kbps

WMA (Windows Media® Audio) Decoding

Format:

Max. Bit Rate: 192 kbps

GENERAL

Power Requirement:

Operating Voltage:

DC 14.4 V (11 V to 16 V allowance)

Grounding System: Negative ground

Allowable Operating Temperature:

0°C to +40°C

Dimensions (W \times H \times D):

Installation Size (approx.):

182 mm \times 52 mm \times 159 mm

Panel Size (approx.):

188 mm \times 58 mm \times 12 mm

Mass (approx.):

1.5 kg (excluding accessories)

Design and specifications are subject to change without notice.



Having TROUBLE with operation?

Please reset your unit

Refer to page of How to reset your unit

JVC



This receiver is designed to operate on **12 V DC, NEGATIVE ground electrical systems**. If your vehicle does not have this system, a voltage inverter is required, which can be purchased at JVC car audio dealers.

Parts list for installation and connection

The following parts are provided for this receiver. After checking them, please set them correctly.

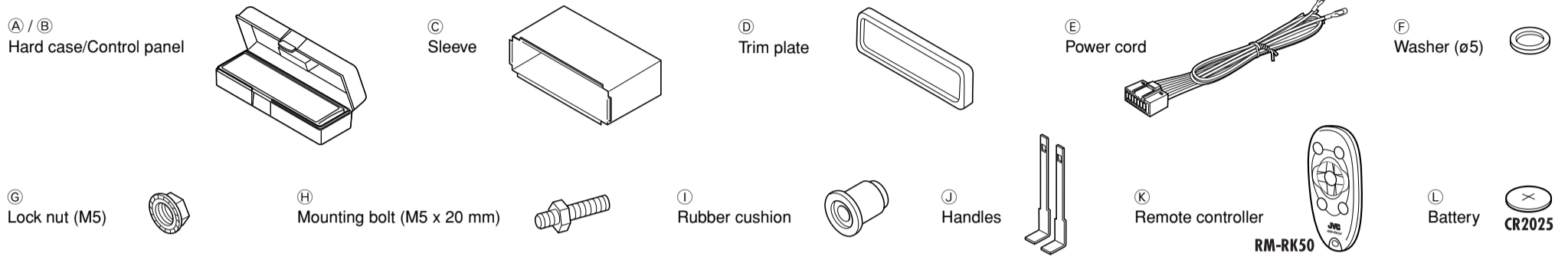

INSTALLATION (IN-DASH MOUNTING)

The following illustration shows a typical installation. If you have any questions or require information regarding installation kits, consult your JVC car audio dealer or a company supplying kits. If you are not sure how to install this receiver correctly, have it installed by a qualified technician.

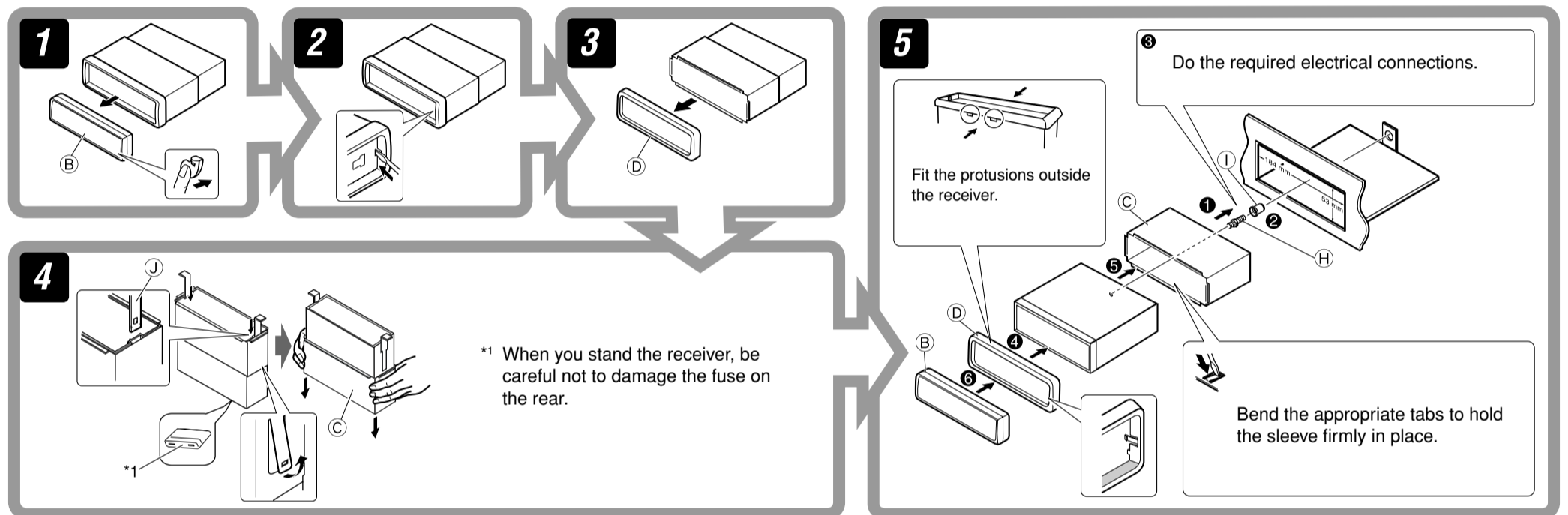

Removing the receiver

Before removing the receiver, release the rear section.

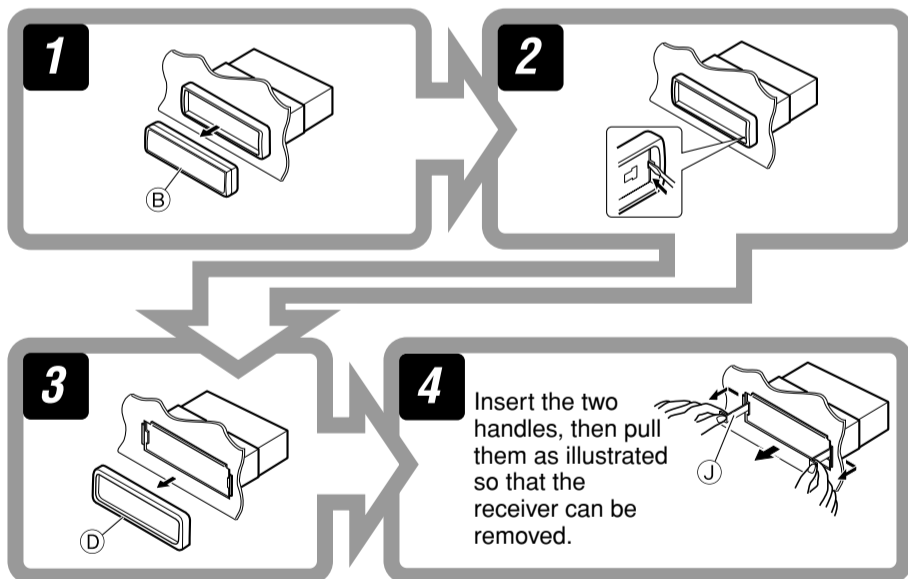

When using the optional stay

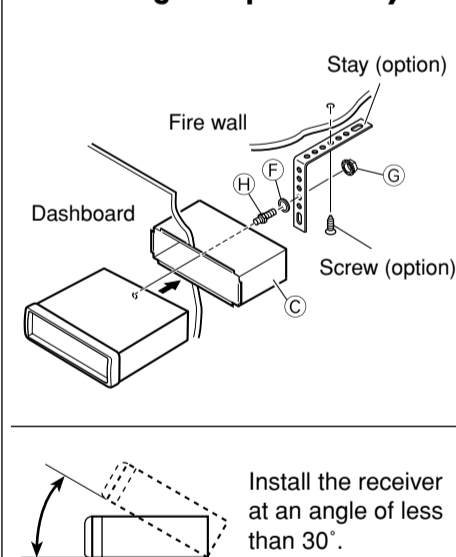

When installing the receiver without using the sleeve

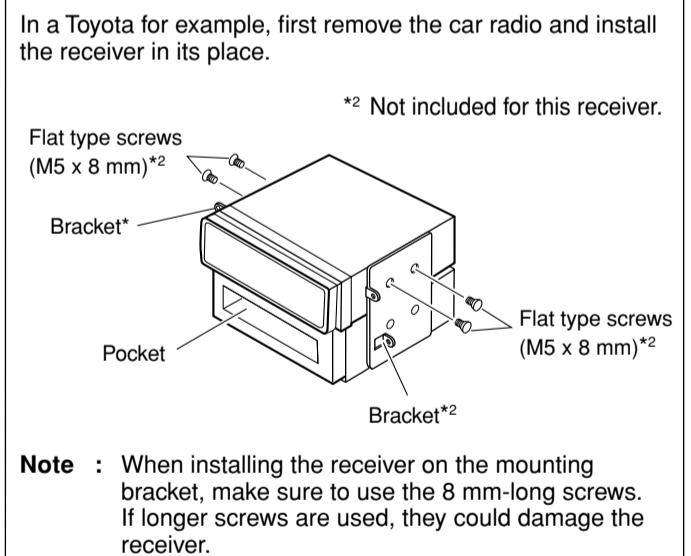

Caution when installing

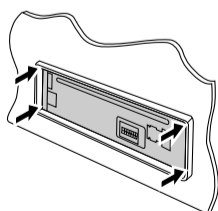

Fit the receiver into the mounting sleeve by using four corners of the trim plate. DO NOT press the panel (shaded in the illustration).

PRECAUTIONS on power supply and speaker connections:

- DO NOT connect the speaker leads of the power cord to the car battery; otherwise, the receiver will be seriously damaged.
- BEFORE connecting the speaker leads of the power cord to the speakers, check the speaker wiring in your car.

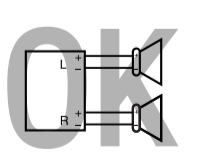
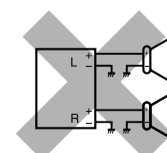
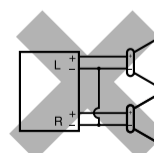

TROUBLESHOOTING

The fuse blows.

- Are the red and black leads connected correctly?

Power cannot be turned on.

- Is the yellow lead connected?

No sound from the speakers.

- Is the speaker output lead short-circuited?

Sound is distorted.

- Is the speaker output lead grounded?

- Are the "-" terminals of L and R speakers grounded in common?

Noise interfere with sounds.

- Is the rear ground terminal connected to the car's chassis using shorter and thicker cords?

Receiver becomes hot.

- Is the speaker output lead grounded?

- Are the "-" terminals of L and R speakers grounded in common?

This receiver does not work at all.

- Have you reset your receiver?

ELECTRICAL CONNECTIONS

To prevent short circuits, we recommend that you disconnect the battery's negative terminal and make all electrical connections before installing the receiver.

• **Be sure to ground this receiver to the car's chassis again after installation.**

Notes:

- Replace the fuse with one of the specified rating. If the fuse blows frequently, consult your JVC car audio dealer.
- It is recommended to connect to the speakers with maximum power of more than 50 W (both at the rear and at the front, with an impedance of 4Ω to 8Ω). If the maximum power is less than 50 W, change "AMP.GAIN" setting to prevent the speakers from being damaged (see page 21 of the INSTRUCTIONS).
- To prevent short-circuit, cover the terminals of the UNUSED leads with insulating tape.
- The heat sink becomes very hot after use. Be careful not to touch it when removing this receiver.

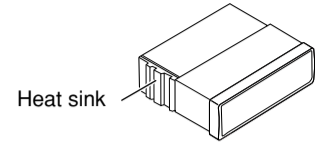

A Typical connections

Before connecting: Check the wiring in the vehicle carefully. Incorrect connection may cause serious damage to this receiver. The leads of the power cord and those of the connector from the car body may be different in color.

- 1 Connect the colored leads of the power cord in the order specified in the illustration below.
- 2 Connect the antenna cord.
- 3 Finally connect the wiring harness to the receiver.

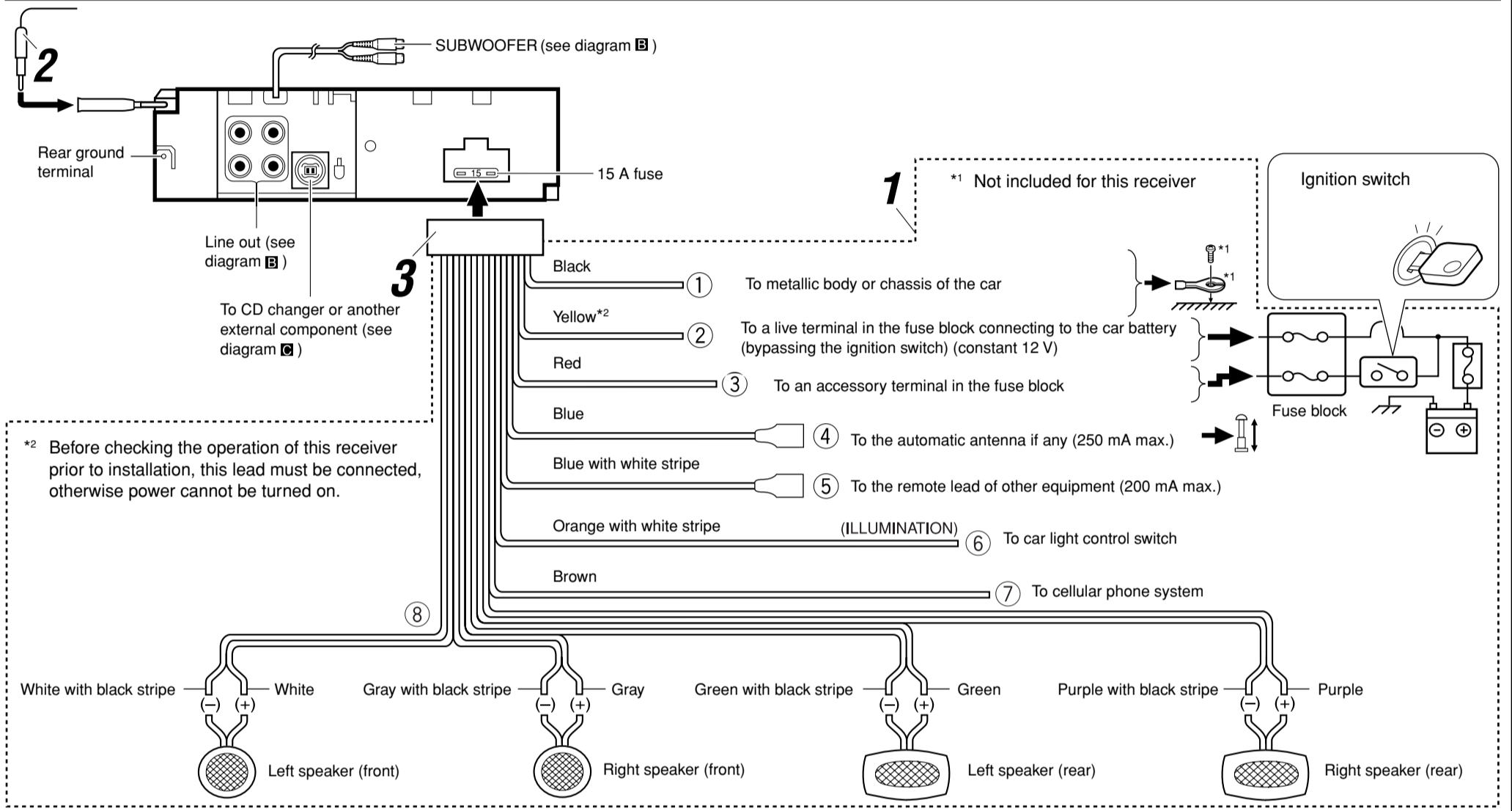

B Connecting the external amplifiers

You can connect amplifiers to upgrade your car stereo system.

- Connect the remote lead (blue with white stripe) to the remote lead of the other equipment so that it can be controlled through this receiver.

• **For amplifier only:**

- **Disconnect the speakers from this receiver, connect them to the amplifier. Leave the speaker leads of this receiver unused.**
- The line output level of this receiver is kept high to maintain the hi-fi sounds reproduced from this receiver.

When connecting an external amplifier to this receiver, turn down the gain control on the external amplifier to obtain the best performance from this receiver.

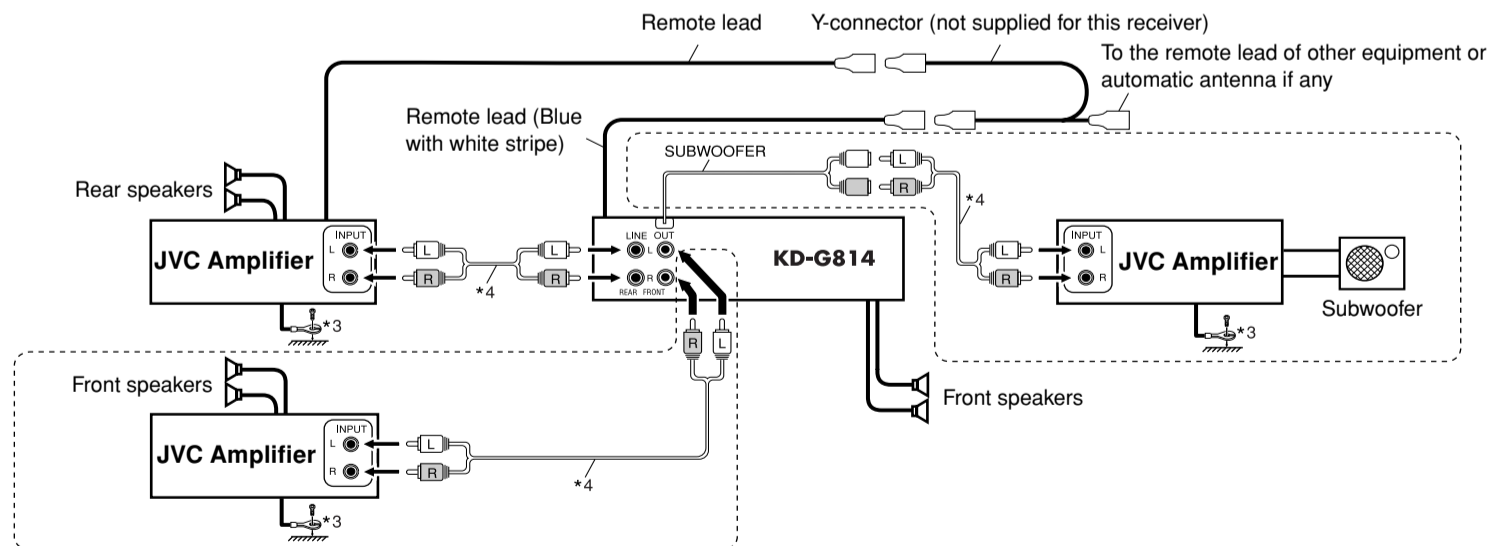

C Connecting other external components

CD changer

- Set "EXTERNAL IN" to "CHANGER" (See page 21 of the INSTRUCTIONS.)

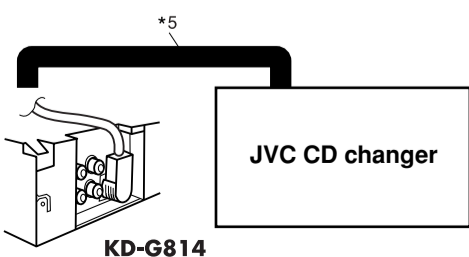

*5 Connecting cord supplied for your CD changer

CAUTION

- Before connecting the CD changer, make sure that the receiver is turned off.

External component

- Set "EXTERNAL IN" to "EXTERNAL IN" (See page 21 of the INSTRUCTIONS.)

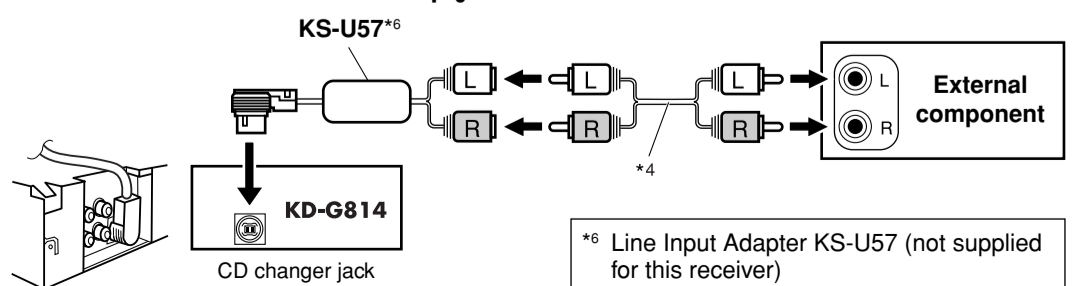

*6 Line Input Adapter KS-U57 (not supplied for this receiver)